

Muto Turbo Blower

H type (Direct Coupled)

Instruction Manual

Read this manual carefully before using the product.

Wrong operations deviating from this manual may lead to serious accidents or damages.

Keep this manual convenient location for easy access.



Muto Denki Corporation

Headquarters: 751, Nishi Hassaku-cho, Midori-ku, Yokohama, Kanagawa, Japan 226-0024

TEL: 81-45-932-2211, FAX: 81-45-932-2219

Osaka Branch: 4-14, Toyosaki 3, Kita-ku, Osaka City, Osaka, Japan 531-0072

TEL: 81-6-6372-1100, FAX: 81-6-6372-1797

Chino Plant: 11400-1107, Aza Harayama, Tamagawa, Chino City, Nagano, Japan 391-0011

TEL: 81-266-79-6071, FAX: 81-266-79-6074

web: <http://www.mutodenki.co.jp>

e-mail: sales@mutodeki.co.jp

Table of contents

1. Introduction	3
2. Safety precautions.....	3
3. Receiving Checkups	5
4. Transportation and Handling.....	5
5. Storage	5
6. Installation.....	5
7. Piping.....	5
8. Connection to Power and Test run	6
9. Precautions for Operation	6
10. Maintenance	7
11. Troubleshooting	9
12. Instruction for Disassembly and Reassembly	10
13. Structural drawing.....	11
14. Motor	12
15. Inquiry	12
16. Limited Warranty	12

1. Introduction

Thank you for purchasing the Muto Turbo Blower.

This manual contains the information you need for handling, installing, operating and maintaining your new equipment correctly, to ensure trouble-free operation and long service life. Please read it thoroughly. After reading this manual, keep it in convenient place for easy access.

The blower is direct coupled type that is devised from direct driven type, so that you need to refer to “the manual of direct driven type” to disassemble and reassemble.

For heat resistant model, its early name contains “H”.

ex. standard model : MIX-8/H5 → heat resistant model : MIXH-8/H5

2. Safety precautions

Before starting any work such as handling, installing, operating and maintaining, carefully read this manual and all documents attached to the product for proper use. Use the product after thorough understanding of all product information, safety information and precautions.

In this manual, safety precautions are classified as “Warning” and “Caution”.



Warning

This tag indicates that wrong operation or use may lead to fatal loss or serious injury.



Caution

This tag indicates that wrong operation or use may lead to human injury or loss of property.

Even the items under  may lead to serious results depending on the circumstances.

Those precautions include very important information and it is strongly recommended to follow them strictly.

Warning

(Place to install)

- The product with non-explosion proof type motor shall not be installed in explosive or inflammable atmospheres. Under those atmospheres, install the product with explosion proof type motor conforming to the degree of danger in that place. Otherwise injuries, explosions or fires may occur.

(Gas)

- Unless otherwise agreed separately, the product can handle only normal air. It is cannot be handled any other gas (explosive, toxic, corrosive, high temperature and so on), liquid or solid materials. Otherwise injuries, explosions or fires may occur.

(Wiring)

- Refer to the instruction manual of motor. Otherwise fires, electrical shocks or explosions may occur.
- Do not touch the wiring. Shut off the power before checking the wiring. Otherwise electrical shocks may occur.

(Operation)

- Do not get close to or look into the open inlet or outlet manifold during the product is running as it is very dangerous as follows.

Warning

Inlet : Clothing which you are wearing or a part of your body will be sucked in. As a result, injuries may occur.

Outlet : A strong wind or flown things may cause injuries.

- Do not insert finger(s) or hand(s) into the opening of the safety covers such as external fan cover and shaft cover. Do not remove the safety cover during the product is running. Otherwise injuries may occur.
- Shut off the main power switch in case of power failure. Otherwise injuries may occur.

(Safety components)

- The product is shipped with metal mesh attached to the inlet and outlet manifold, or otherwise the optional parts are included. If these parts are removed by some reason, take equivalent safety measures. Otherwise injuries may occur.

(Disassembly and Reassembly)

- Before disassembly and reassembly, make sure to shut off the main power and prevent power to be turned on. Otherwise injuries or electrical shocks may occur.

(Others)

- Follow the labels attached to the product. Otherwise serious results may occur.

Caution

(Transportation)

- Check the weight of the product with the specifications, drawing or catalogue before transportation, and be careful not to drop or tip over the product during transportation. Otherwise injuries or breakages may occur.

(Installation)

- Remove all of the inflammable from the product and its vicinity. Otherwise fires may occur.
- Ventilate the room to keep the ambient temperature below 40 deg. C. Otherwise burns, breakages, fires or bearing-damage may occur.

(Operation)

- If the product has high temperature label, do not touch the product with body or hand during the product is running. Take safety measures such as enclosing by fence or net. Otherwise burns may occur.
- Stop operating as soon as abnormality is found. Otherwise injuries, electrical shocks or burns may occur.
- Operate the blower in correct direction for rotation. Otherwise breakages may occur.

(Disassembly and Reassembly)

- Disassembly and reassembly should be done by experts. Otherwise injuries or breakages may occur.
- Do not use the parts of the product on other equipment. Do not use unauthorized parts for the product. Otherwise injuries or breakages may occur.

3. Receiving Checkups

Check if the products you have received are what have been ordered by referring to the order sheet, drawings, invoices, etc.

- (1) Check the nameplates on the blower and the motor, and confirm if it matches what have been ordered.
- (2) Count the number of products received, confirm if it agrees with what have been ordered.
- (3) Check whether there is any breakage during transportation.

4. Transportation and Handling

When transporting the blower, lift the base. Be careful not to give shocks to any parts of the blower.

5. Storage

If the blower is stored before installation, be careful as follows:

- (1) Store the blower in a room where ventilated, not humid nor dusty. Otherwise the blower may have some troubles.
- (2) Before operating the blower which has been stored for long period of time, check if the bearing and the insulation of the motor have no problem. And carefully check if the blower has no abnormality.
- (3) While the blower is stored, rotate the blower shaft several times by hand every month. If this procedure is not performed, the life of the bearing may become short.

6. Installation

The blower should be placed on the flat and rigid foundation with anchor bolt or vibration isolator. If there are gaps between the base and foundation, fill the gaps with thin steel sheets (shimming).

Clear some space around the blower for maintenance.

7. Piping

Turn the blower shaft by hand to verify free rotation without rubbing or noise.

Use rubber sleeves or flexible joints to connect to piping to avoid unnecessary force to the blower and to isolate the vibration from the blower. If direct connection to piping is inevitable, do not give the blower the force by dimensional tolerances, weight of piping, thermal expansion of piping, etc.

8. Connection to Power and Test run

- (1) Check the nameplates of blower and motor and confirm if they agree with the specification for power supply, then connect to power line under instruction by electrical engineer and per electric technical standards and wiring regulation.
- (2) Jog the blower and check the rotational direction is the same as the mark. If the rotational direction is opposite, change the wiring connection. The direction can be reversed by interchanging any two line leads. If the blower runs continuously with reverse rotational direction, it cannot perform as specified and may lead to serious accident.
- (3) Run the blower and measure the electric current (average of each of 3 phase) of the motor. If it exceeds the rated current, use at below the rated current by adjusting the air volume with dumper and so on. After running for a while, if there is no abnormal vibration or noise, test run can be concluded. If any abnormality were found during test run, corrective action should be taken referring to "11. Troubleshooting".

9. Precautions for Operation

Before operating the blower, understand the following thoroughly.

- (1) Continuous use at small air volume will lead to fan durability problem.
- (2) The blower is designed to handle clean air. It cannot handle for air containing particulates and dust, corrosive gases nor inflammable gases. A standard model can handle the air in the range of -15 to 60 deg. C.



Caution

Pay attention to following precaution in case of that heat resistant model operate.

- (3) After starting the blower, temperature of the gas should be raised slowly. Otherwise the blower may be strained by heat expansion.
- (4) When stopping the blower, keep running it until the temperature of the blower descends nearly room temperature. If the blower stops suddenly, the bearing may be broken because the heat is transmitted to it.
- (5) Do not wrap the cooling fan cover in a heat insulator. Otherwise the life of the motor bearing may be shortened because the heat insulator prevents heat loss.

10. Maintenance

The following maintenance is recommended to keep the blower in good condition.

- (1) Pay attention to ventilation to keep the ambient temperature in the range of -15 to 40 deg. C.
- (2) Pay attention to abnormal noise, abnormal vibration, abnormal temperature and air leakage. If abnormality is found, take actions referring to "11. Troubleshooting".
- (3) Lubrication

Note: For motor, refer to the nameplate or the manual of the motor.

 - (a) Grease type, Lubrication amount and Lubrication interval
Refer to the nameplate on the blower.
 - (b) Lubrication procedure
Lubrication can be done during the blower is running, but be careful for rotating object. Turn the shaft by hand when lubricating during the blower is stopped. Inject the grease using a grease gun.
- (4) This coupling meets JIS standards. The only consumable component on the coupling is rubber bush ③ in the figure below. The life of the bush is approximately 1 year.

 **Warning** Turn the power off before disassembly and reassembly.

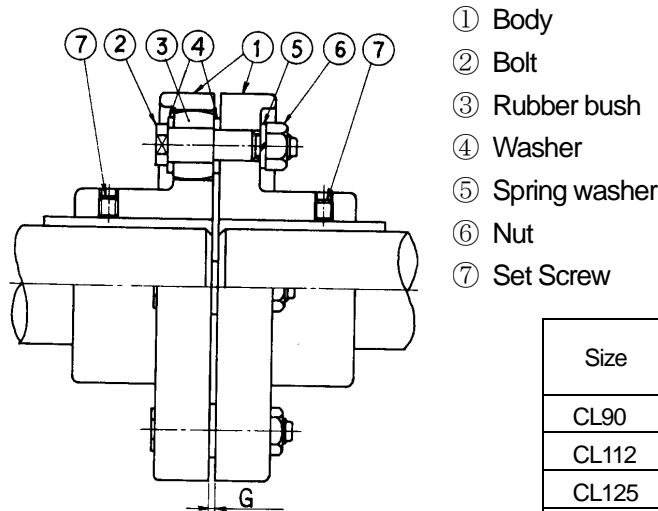

- ① Body
- ② Bolt
- ③ Rubber bush
- ④ Washer
- ⑤ Spring washer
- ⑥ Nut
- ⑦ Set Screw

Size	G dimension mm	Rubber bush Qty.
CL90	3	4
CL112	3	4
CL125	3	4
CL140	3	6

- (a) Replacement procedure of rubber bush
Rubber bush ③ can be replaced without removing body ① from the shaft.
Remove bolts ②, nuts ⑥ and rubber bushes ③ from body ①. Replace with the new rubber bushes ③ and reassemble as they were.

(b) Alignment

(b-1) Tolerance

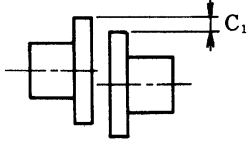
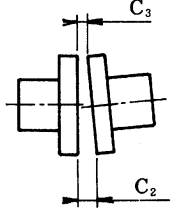
Concentricity	 <p>$C_1 \leq 7.5/100\text{mm}$</p>
Face	 <p>$C_2-C_3 \leq 7.5/100\text{mm}$</p>

(b-2) Measuring

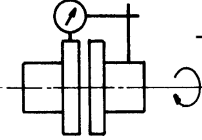
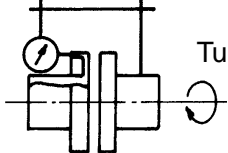
Concentricity	 <p>Turn together</p>
Measure by means of dial indicator or straightedge.	
Face	 <p>Turn together</p>
Measure by means of dial indicator or taper gage.	

(b-3) Realignment

To realign, adjust the motor side to base on the blower side.

Shims to adjust must be flat and made of steel or brass sheet.

After the motor is fixed securely, recheck the alignment again.

- (5) If the blower has filter at the inlet, check the cleanliness of the filter periodically. Replace or clean the filter if and when the air filter is not clean, as it causes pressure loss. The filter can be washed by soaking into water or neutral detergents. (Wash it gently, do not rub or do not squeeze it.) Lay the cleaner side up to dry. It can be cleaned for a few times with this method.

11. Troubleshooting

The following table is for trouble shooting during test run and operation.

Trouble	Cause	What to do
Blown fuse or Tripped circuit breaker	Abnormal voltage or frequency	Consult with power company.
	Inappropriate capacity of power source equipment	Replace with appropriate one.
	Missing phase	Check wiring.
	Imbalanced voltage of phase	Consult with power company.
	Excessive voltage drop	Check the thickness and length of wiring.
	Excessive current	Reduce air volume by dumper.
	Reversed rotation	Change wiring. (interchanging any two line leads)
	Fan touch	Repair or replace.
	Water in the casing	Drain and take some preventive measure.
	Abnormality of bearing	Repair or replace.
Motor over heat	Bad air ventilation for motor	Remove what obstructs the ventilation for motor.
	Running with single phase	Check wiring.
	Abnormality of bearing	Repair or replace.
	Abnormal voltage or frequency	Consult with power company.
Insufficient air pressure or volume	Improper frequency	Consult with Muto.
	Too high ambient air temp.	Improve air ventilation of the room.
	Leakage or clogged piping	Check piping.
	Missing phase	Check wiring.
	Damaged fan, etc.	Repair or replace.
	Reversed rotation	Change wiring. (interchanging any two line leads)
	Dirty or clogging air filter	Clean or replace.
	Lowered motor speed	Consult with Muto.
	Foreign material on the fan	Clean up.
Abnormal noise and/or vibration	Touching or broken fan	Repair or replace.
	Reversed rotation	Change wiring. (interchanging any two line leads)
	Imbalance of fan	Repair or replace.
	Bad bearing	Repair or replace.
	Foreign material or water	Clean up and protect.
	Imbalanced voltage between phase	Consult with power company.
	Missing phase	Check wiring.
	Air leakage	Check piping and repair.
	Weight of piping or force induced by thermal expansion	Get rid of any force to the blower.
	Bad coupling	Repair or replace.
	Coupling misalignment	Realign.
	Shortage of lubrication	Re-lubricate.

12. Instruction for Disassembly and Reassembly

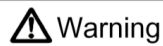

Warning Turn the power off before disassembly and reassembly.

Following is instructive to disassemble and/or to reassemble the blower as referring to “13. Structural drawing” and “the manual of direct driven type”. (It is very difficult to explain all of details of the work perfectly in writing and by sketches. Therefore it is recommended to understand how the parts put together before disassembling and record the direction and order of the parts while disassembling.)

12-1. Disassembly

- (1) Disassemble the main part of the blower as referring to “the manual of direct driven type” until all the fans ⑤ are removed.
- (2) Loosen the band of cover ⑳.
- (3) After removed the bolts that fix fan case (A) ⑧, remove fan case (A) ⑧, cover ㉑, shaft seal ⑩, and spacer ⑪ from Support flange ⑱. (For Heat resistant model, remove the cooling fan.)
- (4) Remove shaft cover ⑦.
- (5) Separate coupling ⑫ and remove motor ⑬.
- (6) After removed the bolts that fix pillow block unit ⑭, remove shaft ⑮ and two pillow block unit together.

Caution : Record the location of liner which might appear under the unit.

- (7) After loosen the set screw of pillow block unit ⑭, Remove the unit from shaft ⑮.

12-2. Cleaning

Clean the disassembled parts. Visually inspect the parts.

12-3. Reassembly

Reassembly is basically the reversed order of disassembly.

Realign for the coupling as referring to “10. Maintenance (4)” securely.

Rotate the shaft by hand and ensure that the fan is not touching.

13. Structural drawings

This drawing is main model. (Some models may be different.)

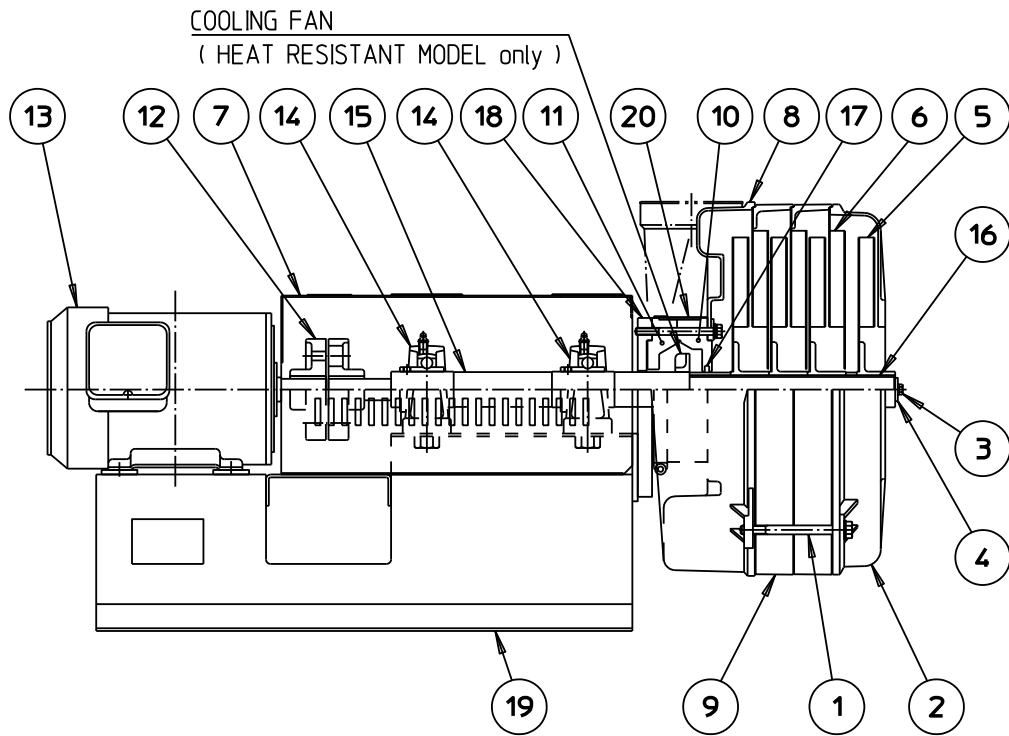

No.	Description	Qty.
1	Fan case fastening bolt	4~
2	Fan case (C)	1
3	Fan stopper bolt	1
4	Fan stopper collar	1
5	Fan	1~
6	Deflector	0~
7	Shaft cover	1
8	Fan case (A)	1
9	Fan case (B)	0~
10	Shaft seal	1
11	Spacer	1
12	Coupling	1
13	Motor	1
14	Pillow block unit	2
15	Shaft	1
16	Fan key	1~
17	Packing	1
18	Support flange	1
19	Base	1
20	Cover	1

14. Motor

Regarding motor, refer to the instruction manual of the motor.

15. Inquiry

If you need to contact us regarding this product, please kindly inform us the information on the nameplate such as CAT. No. , PROD. No. , DATE. In case of troubles, additionally inform us the broken portion, running time (days) and condition used and others.

16. Limited Warranty

The warranty period of this product is one year from the day of shipment unless otherwise specially agreed. Within the period, the malfunctions induced by defects of material or technical reasons will be repaired free of charge. But under following situation, this warranty will not apply to any products.

- (1) Malfunctions that occur past the warranty period
- (2) Malfunctions that occur due to inappropriate usage
- (3) Malfunctions or breakage due to inevitable event such as fire, severe weather, earthquake or such
- (4) By except us, the product has been repaired or modified.

We shall not be responsible for any incidental or consequential damages.

This warranty is valid only for the product used within Japan.

— MEMO —

A series of horizontal dashed lines for writing.

— MEMO —

A series of horizontal dashed lines for writing.

— MEMO —

A series of horizontal dashed lines for writing.

Muto Products

- Muto Wide Blower
- Muto Turbo Blower
- Muto Spencer Blower (Under technical license)
- Muto KF Blower
- Muto Scroll Blower
- Muto Central Vacuum System